

COPPER CONDUCTOR ACCOMMODATED

















AWG	METRIC WIRE SIZE	CAT. NO.    	H 	J DIA.	L	W	T 	TORQUE	
								Lb*in	N*m
8 SOL(.129 DIA.) - 4 STR(.232 DIA.)	[10mm <sup>2</sup> SOL(3.58)- 16mm <sup>2</sup> STR(5.13)]	GB4C	1.49 [38]	3/8-16	.88 [22]	1.06 [27]	1/4"	240	27.0
4 SOL(.204 DIA.)- 2/0 STR(.418 DIA.)	[25mm <sup>2</sup> STR(6.48)- 70mm <sup>2</sup> STR(10.9)]	GB26	1.74 [44]	3/8-16	.94 [24]	1.42 [36]			
		GB26G3 							
GB26SSTN 									
2/0 SOL(.365 DIA.)- 250 KCMIL(.575 DIA.)	[70mm <sup>2</sup> STR(10.9)- 120mm <sup>2</sup> STR(14.4)]	GB29	2.32 [59]	1/2-13	1.25 [32]	1.88 [48]	1/4"	480	54.1
2/0 SOL(.365 DIA.)- 250 KCMIL(.575 DIA.)	[70mm <sup>2</sup> STR(10.9)- 120mm <sup>2</sup> STR(14.4)]	GB29TNGSHDWR 	2.32 [59]	1/2-13	1.25 [32]	1.88 [48]			
300 KCMIL(.630 DIA.)- 500 KCMIL(.814 DIA.)	[150mm <sup>2</sup> STR(16.0)- 240mm <sup>2</sup> STR(20.3)]	GB34	2.57 [65]	1/2-13	1.38 [35]	2.31 [59]			
550 KCMIL(.855 DIA.)- 750 KCMIL(.998 DIA.)	[300mm <sup>2</sup> STR(22.6)- [300mm <sup>2</sup> STR(22.6)]	GB39	3.28 [83]	5/8-11	1.75 [45]	2.75 [70]			
800 KCMIL(1.031 DIA.)- 1000 KCMIL(1.152 DIA.)	[400mm <sup>2</sup> STR(26.1)- 500mm <sup>2</sup> STR(28.3)]	GB44	3.28 [83]	5/8-11	1.75 [45]	3.16 [80]			
660	75								

TABLE A

NOTES:

- MATERIAL: CAST COPPER ALLOY.
- DIMENSIONS IN BRACKETS [ ] ARE IN MILLIMETERS ROUNDED OFF TO THE NEAREST MILLIMETER, UNLESS OTHERWISE NOTED, AND ARE FOR REFERENCE ONLY.
-  FOR BAR THICKNESS FROM 1/4" TO 1 1/4" ADD THE SUFFIX "T" FROM TABLE B TO THE CATALOG NUMBER.
- T2 SHOWN IN TABLE FOR REFERENCE ONLY, T2 NOT TO BE INCLUDED IN CATALOG NUMBER.
-  FOR TIN PLATED PRODUCT ADD A "W" TO THE END OF THE CATALOG NUMBER (EXGB34W OR GB34T6W)
-  CAP & BODY FINISH TO BE TIN PLATED  
HARDWARE FINISH TO BE GALVANIZED STEEL. NOT UL LISTED.
-  FOR GALVANIZED STEEL HARDWARE, ADD SUFFIX "-GS."
- UL 467 LISTED, FILE NO. E9999. ACCEPTABLE FOR DIRECT BURIAL IN EARTH OR CONCRETE, CSA 22.2 NO. 41 LISTED, FILE NO. 42862.
-  FOR TIN PLATED PRODUCT AND HARDWARE ADD A "TN" TO THE END OF THE CATALOG NUMBER
-  SUFFIX CBI INDICATES BOX QTY 100.
-  SUFFIX G3 DENOTES TIN PLATED BODY AND UNPLATED HARDWARE
-  SUFFIX SS DENOTES STAINLESS STEEL HARDWARE

REV	DATE	DESCRIPTION	ECO	BY	C'K.
L	2019-09-05 01:00:00 EDT	UPDATED AS PER FOCUS REQUEST FPN1905022	51408	JL	BE

TABLE B

SUFFIX (T)	T	H ADJUST
T2	.25	0.00
T4	.50	0.25
T6	0.75	0.50
T8	1.00	0.75
T10	1.25	1.00
T14	1.75	1.50

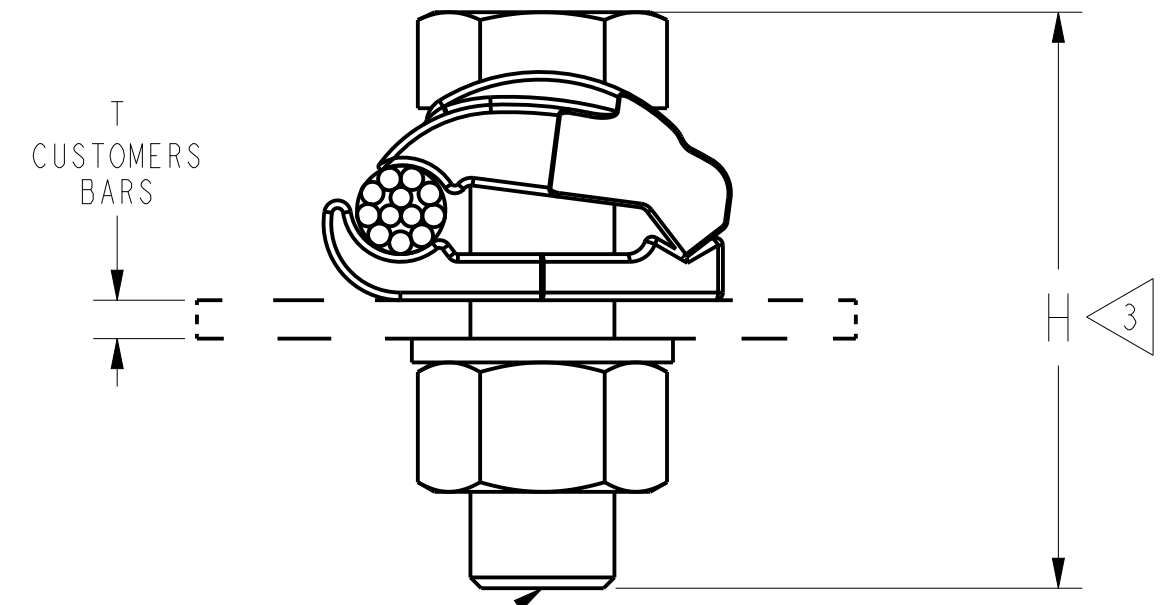
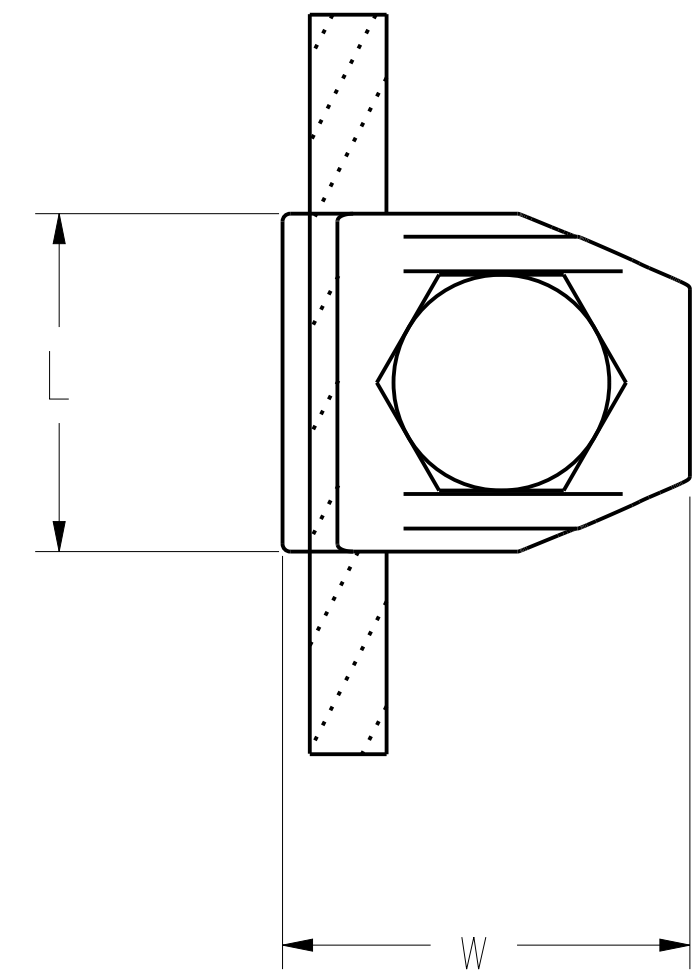

 J DIA SILICON BRONZE  
HEX HEAD BOLT,  
HEX NUT, AND  
SPLIT LOCKWASHER

TO ORDER BURNDY® PRODUCTS CALL  
UNITED STATES:  
1-800-346-4175 (LONDONDERRY, NH)  
CANADA:  
1-800-361-6975 (QUEBEC)  
1-800-387-6487 (ALL OTHER PROVINCES)  
FOR PRODUCT INFO: <http://www.burndy.com>

GROUND CONNECTOR	
ITEM NO:	N/A
CAT. NO:	GB--(TABLE)
DRAWN BY:	HC 09/17/85
CHECKER:	CAR 09/25/85
DSN APPVL:	MJM 10/15/94
MFG APPVL:	--
QA APPVL:	E. VARGAS 04/13/18
MKT APPVL:	K. WOO 11/11/93
PROD FAM:	--
PROJECT #:	--
DOCUMENT TYPE:	Sales
REL LEVEL:	Released
SCALE:	2:1
DRAWING NO	SC091657-01
REV	L
SHEET 1 OF 1	